

HRW

LM Guide Wide Rail Model HRW

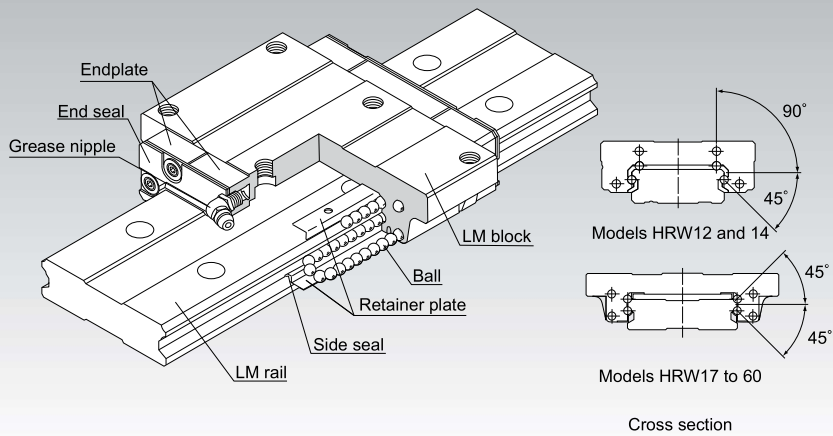

Structure and Features

Balls roll in four rows of raceways precision-ground on an LM rail and an LM block, and endplates incorporated in the LM block allow the balls to circulate.

Since retainer plates hold the balls, they do not fall off even if the LM rail is pulled out. (except models HRW 12 and 14LR).

Each row of balls is placed at a contact angle of 45° so that the rated loads applied to the LM block are uniform in the four directions (radial, reverse radial and lateral directions), enabling the LM Guide to be used in all orientations. In addition, the LM block can receive a well-balanced preload, increasing the rigidity in four directions while maintaining a constant, low friction coefficient. In a low center of gravity structure with a large rail width and a low overall height, this model can be used in places where space saving is required or high rigidity against a moment is required even in a single axis configuration.

[Compact, Heavy Load]

Since the number of effective balls is large, this model is highly rigid in all directions. It can adequately receive a moment even in a single rail configuration.

Additionally, since the second moment of inertia of the rail is large, the rigidity in the lateral directions is also high. Accordingly, it does not need reinforcement such as a side support.

[Self-adjustment Capability]

The self-adjustment capability through front-to-front configuration of THK's unique circular-arc grooves (DF set) enables a mounting error to be absorbed even under a preload, thus to achieve highly accurate, smooth straight motion.

Point of Selection **A 1-10**

Point of Design **A 1-436**

Options **A 1-459**

Model No. **A 1-523**

Precautions on Use **A 1-529**

Accessories for Lubrication **A 24-1**

Mounting Procedure and Maintenance **B 1-89**

Equivalent moment factor **A 1-43**

Rated Loads in All Directions **A 1-58**

Equivalent factor in each direction **A 1-60**

Radial Clearance **A 1-71**

Accuracy Standards **A 1-76**

Shoulder Height of the Mounting Base and the Corner Radius **A 1-449**

Permissible Error of the Mounting Surface **A 1-453**

Dimensions of Each Model with an Option Attached **A 1-472**

Types and Features

Model HRW-CA

The flange of this LM block has tapped holes.
Can be mounted from the top or the bottom.

Specification Table⇒ [A1-242](#)

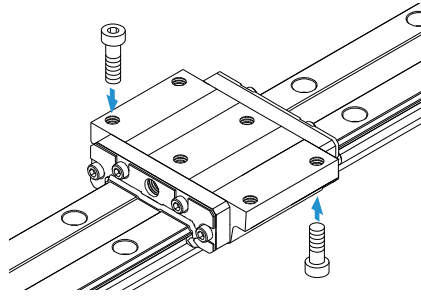

Model HRW-CR

The LM block has tapped holes.

Specification Table⇒ [A1-244](#)

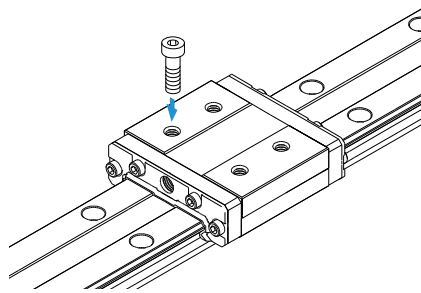

Miniature Type Model HRW-LRM

The LM block has tapped holes.

Specification Table⇒ [A1-244](#)

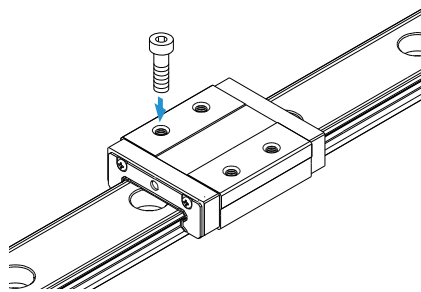

Models HRW-CA and HRW-CAM

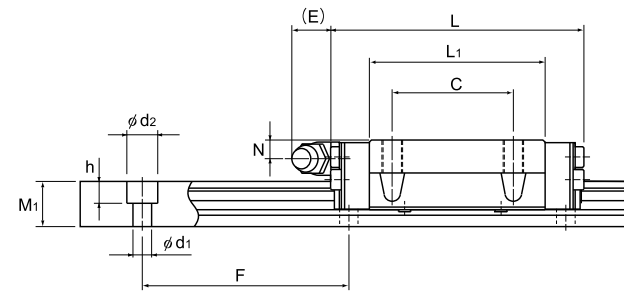
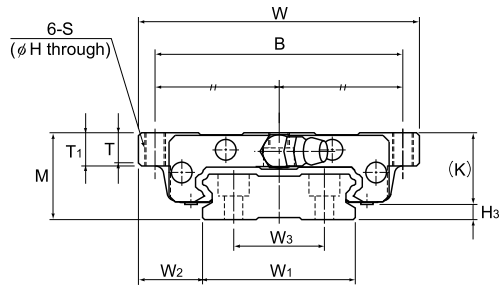

LM Guide

Model No.	Outer dimensions			LM block dimensions											Grease nipple	H ₃
	Height	Width	Length	B	C	H	S	L ₁	T	T ₁	K	N	E			
	M	W	L	B	C	H	S	L ₁	T	T ₁	K	N	E	H ₃		
HRW 17CA HRW 17CAM	17	60	50.8	53	26	3.3	M4	33.6	5.5	6	14.5	4	2	PB107	2.5	
HRW 21CA HRW 21CAM	21	68	58.8	60	29	4.4	M5	40	7.3	8	18	4.5	12	B-M6F	3	
HRW 27CA HRW 27CAM	27	80	72.8	70	40	5.3	M6	51.8	9.5	10	24	6	12	B-M6F	3	
HRW 35CA HRW 35CAM	35	120	106.6	107	60	6.8	M8	77.6	13	14	31	8	12	B-M6F	4	
HRW 50CA	50	162	140.5	144	80	8.6	M10	103.5	16.5	18	46.6	14	16	B-PT1/8	3.4	
HRW 60CA	60	200	158.9	180	80	10.5	M12	117.5	23.5	25	53.5	15	16	B-PT1/8	6.5	

Unit: mm

	LM rail dimensions						Basic load rating		Static permissible moment kN-m*					Mass		
	Width	Height	Pitch		Length*	C	C ₀	M _A		M _B		M _C	LM block	LM rail		
	W ₁ ±0.05	W ₂	W ₃	M ₁	F	d ₁ × d ₂ × h	Max	kN	kN	1 block	Double blocks	1 block	Double blocks	1 block	kg	kg/m
	33	13.5	18	9	40	4.5 × 7.5 × 5.3	1900 (800)	5.53	9.1	0.0464	0.272	0.0464	0.272	0.144	0.15	2.1
	37	15.5	22	11	50	4.5 × 7.5 × 5.3	3000 (1000)	8.02	12.9	0.0784	0.445	0.0784	0.445	0.219	0.25	2.9
	42	19	24	15	60	4.5 × 7.5 × 5.3	3000 (1200)	14.2	21.6	0.166	0.923	0.166	0.923	0.423	0.5	4.3
	69	25.5	40	19	80	7 × 11 × 9	3000 (2120)	33.8	48.6	0.559	3.03	0.559	3.03	1.59	1.4	9.9
	90	36	60	24	80	9 × 14 × 12	3000	62.4	86.3	1.32	7.08	1.32	7.08	3.67	4	14.6
	120	40	80	31	105	11 × 17.5 × 14	3000	80.3	109	1.88	10.1	1.88	10.1	6.17	5.7	27.8

Note) The maximum length under "Length*" indicates the standard maximum length of an LM rail. (See **A1-246**.)
 Static permissible moment* 1 block: the static permissible moment with one LM block
 Double blocks: static permissible moment when two LM blocks are in close contact with each other
 Total block length L : The total block length L shown in the table is the length with the dust proof parts, code UU or SS.
 If other contamination protection accessories or lubricant equipment are installed, the total block length will increase.
 (See **A1-472** or **A1-492**)
 The M in the model number symbol indicates that the LM block, LM rail and balls are made of stainless steel.
 The stainless steel provides excellent corrosion and environmental resistance.

Model number coding

HRW35 CA 2 UU C1 M +1000L P T M

Model number	Type of LM block	Contamination protection accessory symbol (*1)	Stainless steel LM block	LM rail length (in mm)	Symbol for LM rail jointed use	Stainless steel LM rail
No. of LM blocks used on the same rail	Radial clearance symbol (*2)	Accuracy symbol (*3)	Normal (No symbol)	Normal grade (No Symbol)/High accuracy grade (H)	Precision grade (P)/Super precision grade (SP)	Ultra precision grade (UP)

(*1) See contamination protection accessory on **A1-496**. (*2) See **A1-71**. (*3) See **A1-76**.

Models HRW-CR, HRW-CRM and HRW-LRM

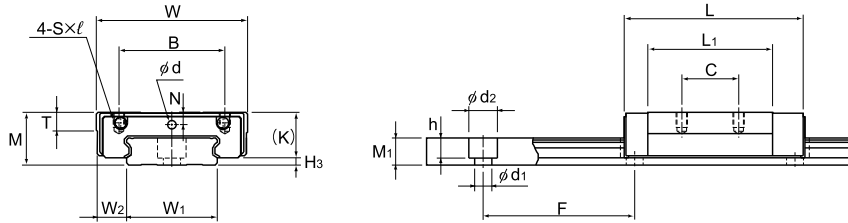

Models HRW12 and 14LRM

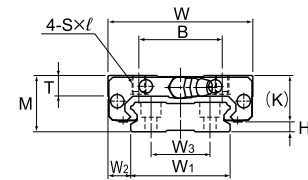

Models HRW17 and 21CR/CRM

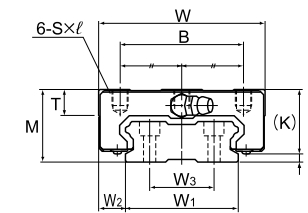

Models HRW27 to 50CR/CRM

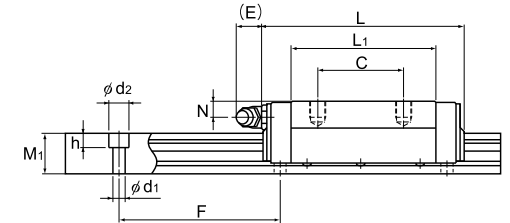

Unit: mm

Model No.	Outer dimensions			LM block dimensions										H ₃
	Height	Width	Length	B	C	S×l	L ₁	T	K	N	E	Greasing hole	Grease nipple	
	M	W	L									d		
HRW 12LRM	12	30	37	21	12	M3×3.5	27	4	10	2.8	—	2.2	—	2
HRW 14LRM	14	40	45.5	28	15	M3×4	32.9	5	12	3.3	—	2.2	—	2
HRW 17CR HRW 17CRM	17	50	50.8	29	15	M4×5	33.6	6	14.5	4	2	—	PB107	2.5
HRW 21CR HRW 21CRM	21	54	58.8	31	19	M5×6	40	8	18	4.5	12	—	B-M6F	3
HRW 27CR HRW 27CRM	27	62	72.8	46	32	M6×6	51.8	10	24	6	12	—	B-M6F	3
HRW 35CR HRW 35CRM	35	100	106.6	76	50	M8×8	77.6	14	31	8	12	—	B-M6F	4
HRW 50 CR	50	130	140.5	100	65	M10×15	103.5	18	46.6	14	16	—	B-PT1/8	3.4

	LM rail dimensions						Basic load rating		Static permissible moment kN-m ²					Mass		
	Width		Height/Pitch		Length*	C	C ₀	M _A		M _B		M _C	LM block	LM rail		
	W ₁ ±0.05	W ₂	W ₃	M ₁				F	d × d × h	Max	kN	kN			1 block	Double blocks
	18	6	—	6.5	40	4.5×8×4.5	(1000)	3.29	7.16	0.0262	0.138	0.013	0.069	0.051	0.045	0.79
	24	8	—	7.2	40	4.5×7.5×5.3	(1430)	5.38	11.4	0.0499	0.273	0.025	0.137	0.112	0.08	1.2
	33	8.5	18	9	40	4.5×7.5×5.3	1900 (800)	5.53	9.1	0.0464	0.272	0.0464	0.272	0.144	0.12	2.1
	37	8.5	22	11	50	4.5×7.5×5.3	3000 (1000)	8.02	12.9	0.0784	0.445	0.0784	0.445	0.219	0.19	2.9
	42	10	24	15	60	4.5×7.5×5.3	3000 (1200)	14.2	21.6	0.166	0.923	0.166	0.923	0.423	0.37	4.3
	69	15.5	40	19	80	7×11×9	3000 (2120)	33.8	48.6	0.559	3.03	0.559	3.03	1.59	1.2	9.9
	90	20	60	24	80	9×14×12	3000	62.4	86.3	1.32	7.08	1.32	7.08	3.67	3.2	14.6

Model number coding

HRW27 CR 2 UU C1 M +820L P T M

Model number	Type of LM block	Contamination protection accessory symbol (*1)	Stainless steel LM block	LM rail length (in mm)	Symbol for LM rail jointed use	Stainless steel LM rail
	No. of LM blocks used on the same rail	Radial clearance symbol (*2) Normal (No symbol) Light preload (C1) Medium preload (C0)	Radial clearance symbol (*2) Normal (No symbol) Light preload (C1) Medium preload (C0)	Accuracy symbol (*3) Normal grade (No Symbol)/High accuracy grade (H) Precision grade (P)/Super precision grade (SP) Ultra precision grade (UP)		

(*1) See contamination protection accessory on [A1-496](#). (*2) See [A1-71](#). (*3) See [A1-76](#).

Note1) The maximum length under "Length*" indicates the standard maximum length of an LM rail. (See [A1-246](#))
 Static permissible moment² 1 block: the static permissible moment with one LM block
 Double blocks: static permissible moment when two LM blocks are in close contact with each other
 Total block length L : The total block length L shown in the table is the length with the dust proof parts, code UU or SS. If other contamination protection accessories or lubricant equipment are installed, the total block length will increase.
 (See [A1-472](#) or [A1-492](#))
 The M in the model number symbol indicates that the LM block, LM rail and balls are made of stainless steel. The stainless steel provides excellent corrosion and environmental resistance.
 Note2) The basic load rating in the dimension table is for a load in the radial direction. Use Table7 on [A1-58](#) to calculate the load rating for loads in the reverse radial direction or lateral direction for models 12 and 14, as those values are different.

Standard Length and Maximum Length of the LM Rail

Table1 shows the standard and maximum lengths of the HRW model rail. If a rail length longer than the listed max length is required, rails may be jointed to meet the overall length. Contact THK for details. For special rail lengths, it is recommended to use a value corresponding to the G dimension from the table. As the G dimension increases, this portion becomes less stable and the accuracy performance is severely impacted. For the G dimension when a special length is required, we recommend selecting the corresponding G value from the table. The longer the G dimension is, the less stable the G area may become after installation, thus causing an adverse impact to accuracy.

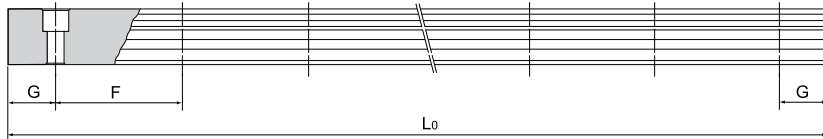

Table1 Standard Length and Maximum Length of the LM Rail for Model HRW

Unit: mm

Model No.	HRW 12	HRW 14	HRW 17	HRW 21	HRW 27	HRW 35	HRW 50	HRW 60
LM rail standard length (L ₀)	70	70	110	130	160	280	280	570
	110	110	190	230	280	440	440	885
	150	150	310	380	340	760	760	1200
	190	190	470	480	460	1000	1000	1620
	230	230	550	580	640	1240	1240	2040
	270	270		780	820	1560	1640	2460
	310	310					2040	
	390	390						
	470	470						
		550	670					
Standard pitch F	40	40	40	50	60	80	80	105
G	15	15	15	15	20	20	20	22.5
Max length	(1000)	(1430)	1900 (800)	3000 (1000)	3000 (1200)	3000 (2120)	3000	3000

Note1) The maximum length varies with accuracy grades. Contact THK for details.

Note2) If jointed rails are not allowed and a greater length than the maximum values above is required, contact THK.

Note3) The figures in the parentheses indicate the maximum lengths of stainless steel made models.

Prevention of LM block from falling off of LM rail

In miniature model HRW, the balls fall out if the LM block comes off the LM rail.

For this reason, LM Guide assemblies are delivered with a part which prevents the LM block from coming off the rail. If you remove this part when using the product, please take precautions to avoid overrunning the blocks off of the rail.